



TIEMME

COLLETTORI COMPLANARI Complanar manifolds

Serie **1905-1906**

Collettori complanari componibili con attacchi 1/2"x16 per tubi rame, PE-X e multistrato. Disponibile con mandata da 3/4" o 1".

Modular complanar manifolds with connections 1/2"x16 for copper, PE-X and multilayer pipes. Available with delivery size 3/4" or 1".

I collettori di distribuzione "COMPLANARI" sono del tipo componibile e sono generalmente utilizzati nelle reti di distribuzione di acqua calda e fredda. Grazie alla loro configurazione permettono l'alimentazione in parallelo delle utenze per acqua calda e/o fredda riducendo al minimo le perdite di carico.

I collettori sono prodotti in conformità alle normative in materia e sono certificati relativamente alla composizione chimica dei materiali impiegati ed a livello dimensionale.

The distribution manifolds "COMPLANARI" are modular and are typically used for hot and cold water distribution. Due to the configuration they may be used to distribute cold/hot water in parallel reducing at minimum the pressure drop.

The manifolds are produced according to the relevant rules and are certified for material chemical composition and dimensional request.



Per la gamma completa vedere il catalogo / For complete range see catalogue

Caratteristiche Tecniche

Temperatura max di esercizio: 110°C
Temperatura min di esercizio: -20°C
Pressione max di esercizio: 10 bar
Filettature: femmina ISO 228
maschio ISO 228

Technical Features

Maximum temperature: 110°C
Minimum temperature: -20°C
Maximum operating pressure: 10 bar
Threads: female ISO 228
male ISO 228

Descrizione

Corpo
O-rings
Vite

Materiale

Ottone CW617N - EN12165
Gomma nitrilica NBR
Acciaio

Trattamento

-
-
Brunito

Description

Body
O-rings
Bolt

Material

CW617N-EN12165 brass
Nitrile Rubber NBR
Steel

Treatment

-
-
Burnished

Certificazioni / Certifications

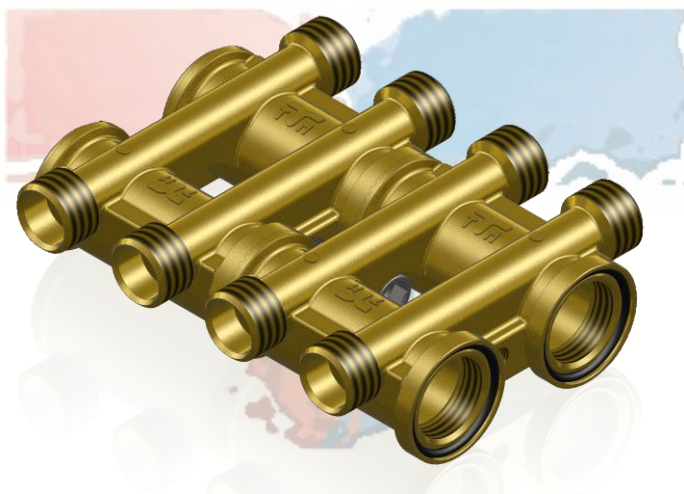

TIEMME Raccorderie S.p.A. si riserva di apportare modifiche in qualsiasi momento senza preavviso.
TIEMME Raccorderie S.p.A. reserves the right to modify contents in any time without prior advise.
È vietata qualsiasi forma di riproduzione, se non autorizzata.
Is forbidden any reproduction unless under TIEMME autorization



TIEMME Raccorderie S.p.A.
Via Cavallera 6/A (Loc. Barco) - 25045 Castegnato (Bs) - Italy
Tel +39 030 2142211 R.A. - Fax +39 030 2142206
info@tiemme.com - www.tiemme.com

©TIEMME Raccorderie S.p.A. COMPLANARI-1900 Rev E 07-12





TIEMME

COLLETTORI COMPLANARI Complanar manifolds

Serie 1905-1906



Tabella dimensioni / *Sizes table*

Size	Vie/ Ways	A	B	ØC	D	E	F	G	G1	G2	H	I	L	L1	Codice/ Code
3/4"	2x2	3/4"	1/2"	16,2	10	11	11	0	36	50	20	19	75,0	113	1905N050402
	4x4	3/4"	1/2"	16,2	10	11	11	37,3	36	50	20	19	148,3	113	1905N050404
	6x6	3/4"	1/2"	16,2	10	11	11	37,3	36	50	20	19	221,6	113	1905N050406
	8x8	3/4"	1/2"	16,2	10	11	11	37,3	36	50	20	19	294,9	113	1905N050408
	10x10	3/4"	1/2"	16,2	10	11	11	37,3	36	50	20	19	368,2	113	1905N050410
1"	2x2	1"	1/2"	16,2	10	17	15	0	48	60	25,75	24,25	98,0	129	1906N060402
	4x4	1"	1/2"	16,2	10	17	15	48	48	60	25,75	24,25	194,2	129	1906N060404
	6x6	1"	1/2"	16,2	10	17	15	48	48	60	25,75	24,25	290,4	129	1906N060406
	8x8	1"	1/2"	16,2	10	17	15	48	48	60	25,75	24,25	386,6	129	1906N060408
	10x10	1"	1/2"	16,2	10	17	15	48	48	60	25,75	24,25	482,8	129	1906N060410

TIEMME Raccorderie S.p.A. si riserva di apportare modifiche in qualsiasi momento senza preavviso.
 TIEMME Raccorderie S.p.A. reserves the right to modify contents in any time without prior advise.
 È vietata qualsiasi forma di riproduzione, se non autorizzata.
 is forbidden any reproduction unless under TIEMME autorization

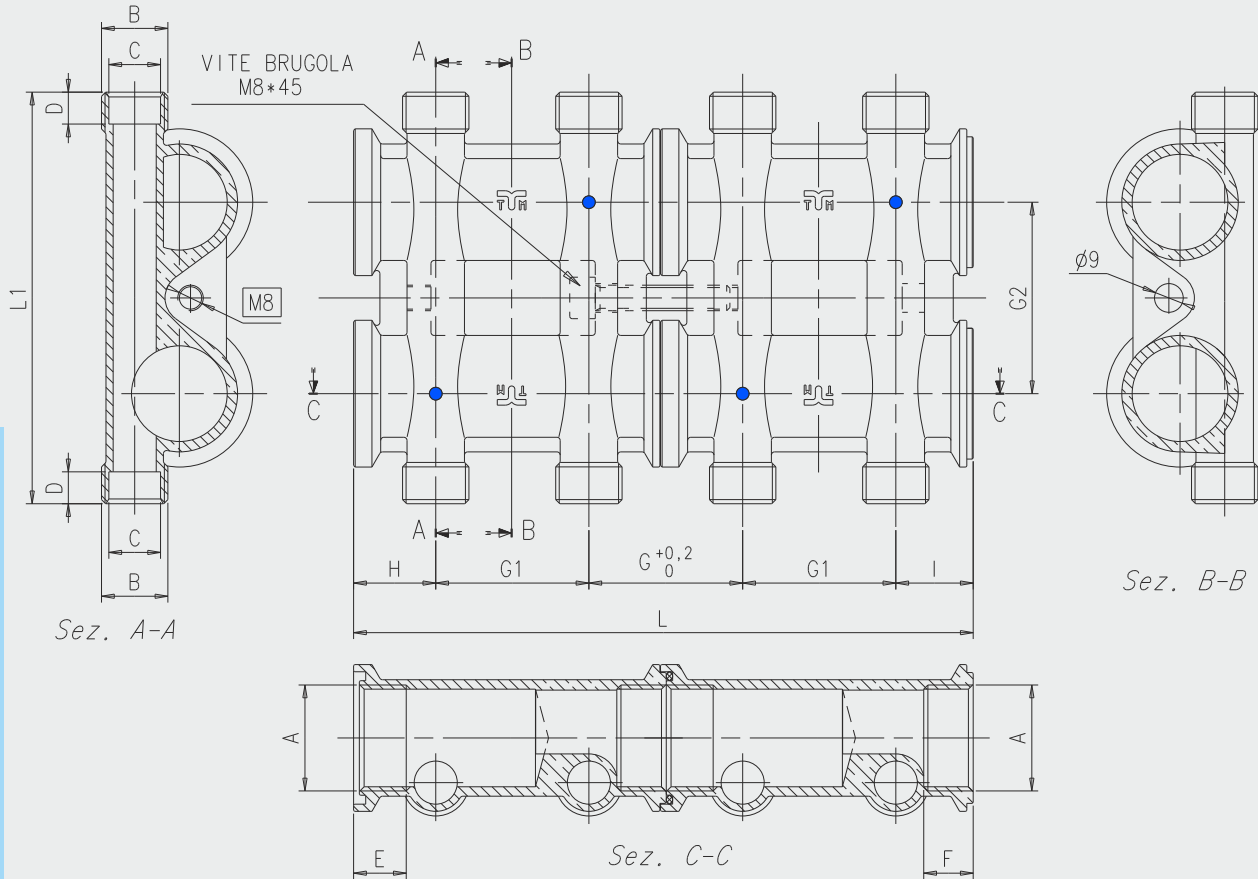

TIEMME Raccorderie S.p.A.
 Via Cavallera 6/A (Loc. Barco) - 25045 Castegnato (Bs) - Italy
 Tel +39 030 2142211 R.A. - Fax +39 030 2142206
 info@tiemme.com - www.tiemme.com

©TIEMME Raccorderie S.p.A. COMPLANARI-1900 Rev E 07-12





TIEMME

COLLETTORI COMPLANARI Complanar manifolds

Serie 1905-1906

Cassette utilizzabili
Boxes used

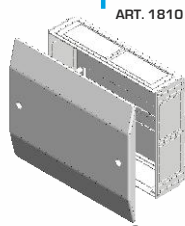

ART. 1810

Cassetta universale
Universal box

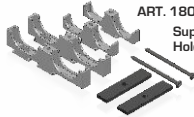

ART. 1809

Supporti per collettori
Holding set for manifolds

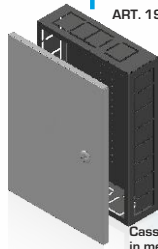

ART. 1920-1930

Cassetta universale
in metallo
Universal metallic box

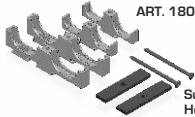

ART. 1809

Supporti per collettori
Holding set for manifolds

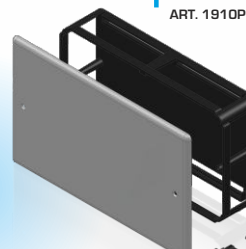

ART. 1910P

Cassetta universale
«JOLLY» Universal
box

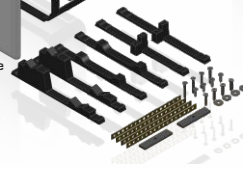

ART. 1800

Cassetta per
collettori «TOTEM,
COMPLANARE
e COMPATTO»
Box for «TOTEM,
COMPLANARE
and COMPATTO»
manifolds



Guida alle connessioni ed esempio di utilizzo
Fitting guide and use example

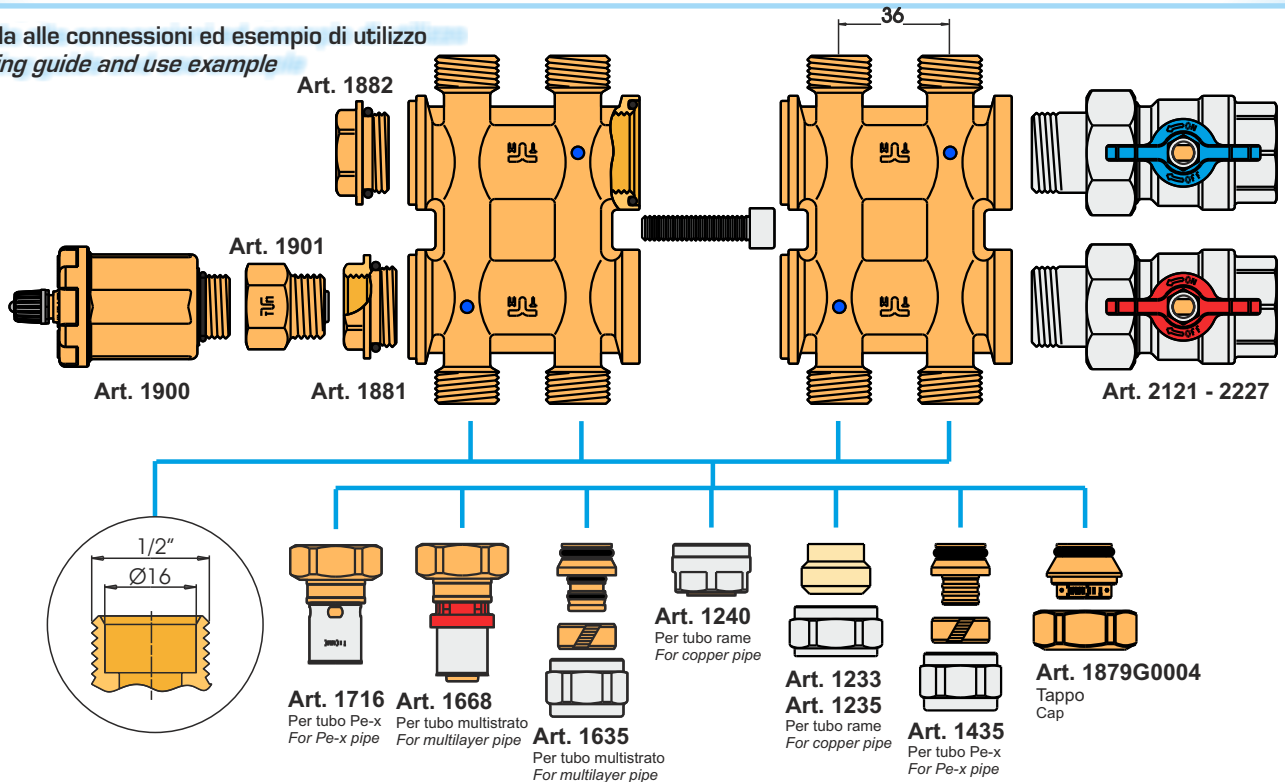

TIEMME Raccorderie S.p.A. si riserva di apportare modifiche in qualsiasi momento senza preavviso.
TIEMME Raccorderie S.p.A. reserves the right to modify contents in any time without prior advise.
È vietata qualsiasi forma di riproduzione, se non autorizzata.
is forbidden any reproduction unless under TIEMME authorization



TIEMME Raccorderie S.p.A.
Via Cavallera 6/A (Loc. Barco) - 25045 Castagnato (Bs) - Italy
Tel +39 030 2142211 R.A. - Fax +39 030 2142206
info@tiemme.com - www.tiemme.com

©TIEMME Raccorderie S.p.A. COMPLANARI-1900 Rev E 07-12

